



Antreg[®]

Technology experts

Rifles ARS M4s[®]



A photograph of three soldiers in a forest. One soldier is in the foreground on the left, another is in the middle ground, and a third is on the right. They are all wearing tactical gear and holding rifles. The scene is dimly lit, with sunlight filtering through the trees.

ABOUT US

ANTREG, a.s. has a distinguished history going all the way back to 1952. At one point, it was a plant within the Zbrojovka Brno state enterprise. In 1992, this plant was privatized.

But enough history—let's look at Antreg today. The company's key product is ARS M4s® rifles. After more than two years of testing and fine-tuning down to the tiniest details, the ARS M4s® arrived on both Czech and international markets in 2019. Despite its brief history, Antreg's ARS M4s® has earned numerous shooter's respect. Our company is constantly expanding and building its infrastructure, and thus with our nearly one hundred employees and our top-rate machinery, we can make a rifle that's appreciated by both sports shooters and clients oriented towards tactical disciplines. Its inclusion into the arsenals of both military and police units abroad is a chapter all its own. Our rifle is inarguably at the top of its class—as you'll agree once you've tried it out.

But still, why choose Antreg's rifle specifically? The reasons are many: reliability in every situation, first-rate Lothar Walther barrels, unrivaled workshop processing, production of nearly all parts in-house, aerospace certification of the materials used for production, Magpul buttstock and pistol grip, and MIL-SPEC compatible parts.

Without your passion for shooting and our sense for precision, we'd never achieve the great results we have today. Our thanks go out mainly to everyone who browses our catalogs and everyone who already owns an ANTREG rifle.



ANTREG a.s.

Tovární 810/8d, 682 01 Vyškov
Czech Republic

Business ID: : 25306821
Tax ID: CZ25306821

www.ANTREG.cz



Photography: Michal Šteflovíč and Petr Bařina

Upper receiver

Upper receiver made of hardened AW7075-T6 aluminum, with aerospace-approved material quality. Its aluminum parts boast a tough elox exterior coating layer.

Ambidextrous charging handle

The gripping part of the charging handle is shaped for a good grip during handling. Its aluminum parts boast a tough elox exterior protection layer.

Forward assist for action system

Critical when the gun is heavily fouled from shooting.

Buttstock

Magpul CTR MIL-Spec.

Pistol grip

Magpul MOE, with an interior space for accessories.

Ambidextrous safety selector switch

Ambidextrous safety selector switch configurable from 60° to 90°.

Ambidextrous bolt catch

Integrated bolt catch release, on both left and right sides, in reach of pointer finger.

Bolt carrier group

The bolt carrier group and bolt are both designed to work reliably even under tough conditions.

Dust cover

Provides maximum dust protection for the action system even under tough conditions.

Piston

Standard piston and Sports piston are available. Choose the Sports piston for significant recoil reduction. The piston's shape affects gas expansion in the gas block.

Piston rod

The piston rod, along with the buffer spring, provides for the transfer of energy to the bolt assembly.

Color designs

Our weapons' basic color designs:

- Black
- Cerakote H-267 flat dark earth
- Cerakote H-294 midnight bronze
- Cerakote H-234 sniper gray

Custom color designs

We offer custom color designs for your weapon from Cerakote's official sampler.

Gas regulator

3-position regulation system, with the option for ammo switching at high temperatures.

Gas block

Like the gun's buffer tube, its gas block is designed to enable shooting immediately after surfacing from underwater.

Barrel

The interior and exterior surfaces of the first-rate Lothar Walther barrels are treated with Salt Bath Nitriding.

Handguard

The handguard can be assembled and disassembled without special tools. In field conditions, ammo is enough. This is a free-floating handguard.

Muzzle devices

Made from tempered stainless steel with a black surface treatment. Muzzle brake and 3-pronged flash hider, with the option of attaching a silencer.

Ambidextrous magazine release

The release is protected against unintentional releasing of the magazine during the rifle's handling.

Lower receiver

The lower receiver is made of hardened AW7075-T6 aluminum, with aerospace-approved material quality. The aluminum parts have a tough elox exterior coating layer.

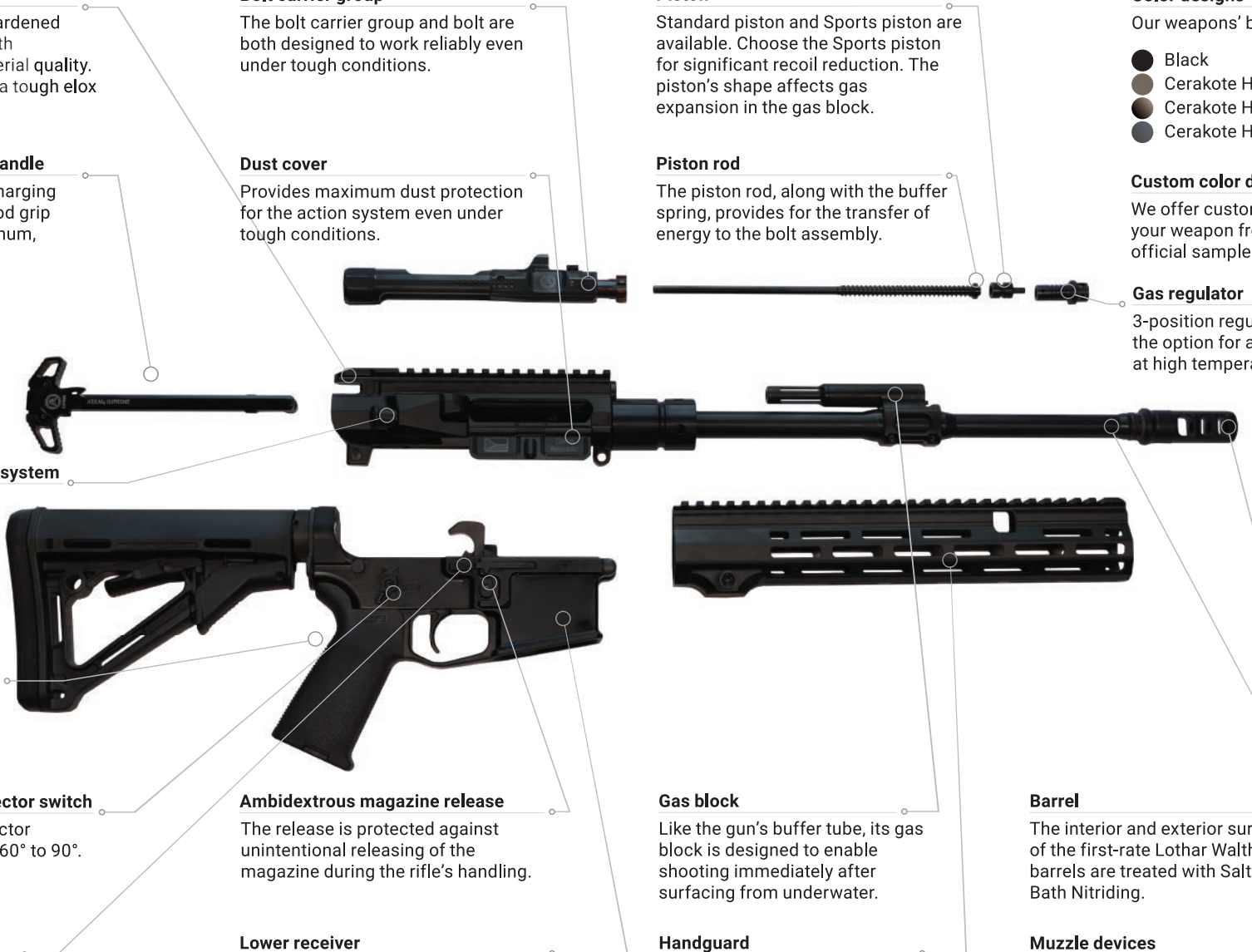

HANDGUARDS

MADE FOR MID LENGTH

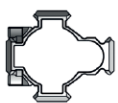
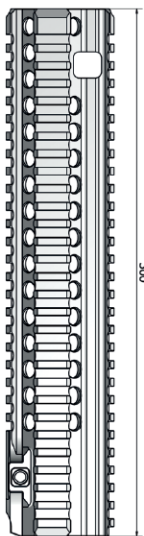
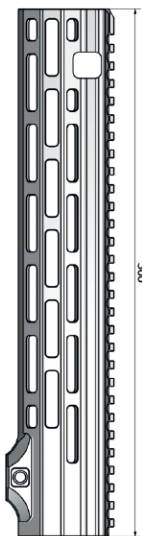
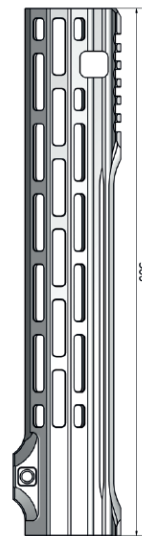
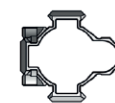
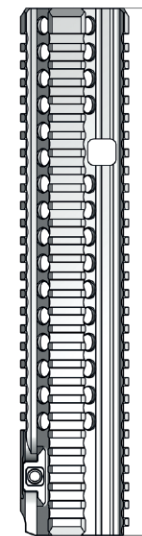
**QUADRAIL300**Side port for easy access
to the gas regulator**M-LOK300 +
PICATINNY TOP**Side port for easy access
to the gas regulator**M-LOK300 PRO +
PICATINNY TOP**Side port for easy access
to the gas regulator**QUADRAIL300**Side port for easy access
to the gas regulator

The handguard fully qualifies as a free-floating handguard and is designed to serve as a carrier for tactical equipment while also providing a strong and reliable grip. It is attached to the barrel nut and allows it to vibrate freely. Our handguards are manufactured from tempered aluminum, with a surface that's treated with a thick layer of hard elox—and this equally applies for rifles in Cerakote® colors. Two rail types are available for attaching accessories: the Stanag 4694 NATO (Picatinny 1913 compatible) standard rail system, or attachment using M-LOK slots in combination with a NATO upper rail. All sharp edges have been beveled and rounded for greater comfort of use. And this also significantly increases lifespan and reliability when repeatedly attaching tactical accessories. Beveled and rounded edges offer far better resistance to friction and wear-and-tear. We also emphasize the ability of our weapons and their components to keep on looking like new for as long as possible.

HANDGUARDS



MADE FOR THE CARBINE LENGTH

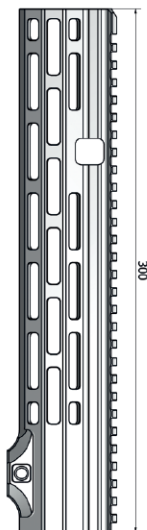

**M-LOK300 +
PICATINNY TOP**

Side port for easy access
to the gas regulator

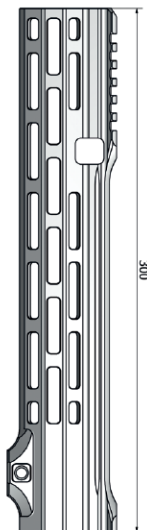

**M-LOK300 PRO +
PICATINNY TOP**

Side port for easy access
to the gas regulator

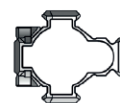
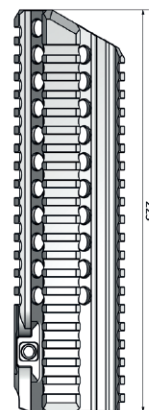

QUADRAIL225

Direct access to
the gas regulator

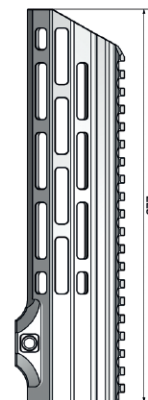

**M-LOK225 +
PICATINNY TOP**

Direct access to
the gas regulator

COMPONENT

SPORT PISTON

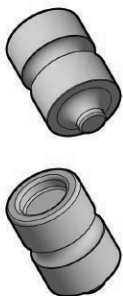

SPORT PISTON

Significantly reduces weapon recoil.
Can be ordered separately.

FLASH HIDER



ANTREG VULCAN F1®

3-prong flash hider with maximum effectiveness even when a short barrel is used. Possibility of attaching a silencer.

MUZZLE BRAKE



ANTREG VULCAN M1®

This muzzle brake stabilizes the barrel during a shot, reducing recoil. Possibility of attaching a silencer.

Patented Antreg sports piston - a component of the gas regulator, which is part of the gas block. It alters the flow of gases in the gas block in an entirely new way. The gas block is pressurized just as in the standard (military) piston variant, but the dynamic with which the piston passes pressure to the piston rod is changed. With this revolutionary solution, we have achieved exceptionally significant recoil reduction relative to the standard Antreg piston. But far more important is the fact that Antreg's developers have eliminated recoil by up to 75% compared to competing AR-15 rifles of both piston and gas types.



COMPONENTS

AMBIDEXTROUS 60°/90° SAFETY SELECTOR SWITCH

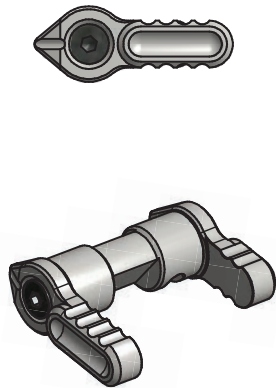

AMBIDEXTROUS 60°/90° SAFETY SELECTOR SWITCH

Manufactured from high-quality tool steel. The safety selector switch is furnished with grooves along the sides enabling safe handling in gloves. Supplied with two arm lengths, 15 and 20 mm from the center of rotation, exchangeable based on the shooter's preference.

AMBIDEXTROUS MAGAZINE RELEASE

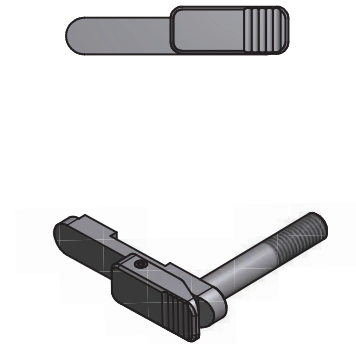

AMBIDEXTROUS MAGAZINE RELEASE

After replacement of the standard magazine catch the magazine can be released with either the right or left hand. The design enables the use of this part even with an extended bottom surface under the catch. Just as in the original component manufactured to MIL-SPEC, inch button threading is used."

AMBIDEXTROUS CHARGING HANDLE

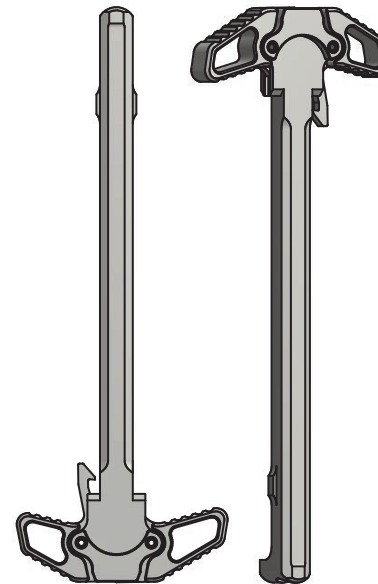

AMBIDEXTROUS CHARGING HANDLE

After replacement of the standard magazine catch the magazine can be released with either the right or left hand. The design enables the use of this part even with an extended bottom surface under the catch. Just as in the original component manufactured to MIL-SPEC, inch button threading is used."

ATTACHING M-LOK RAIL

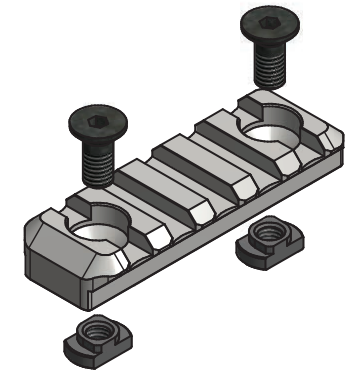

ATTACHING M-LOK RAIL

Comes in variants with 5 and 7 rail slots. Material: aerospace aluminum. Its surface is treated with hardened and polished elox.



ARS M4s[®] 0Q[®]

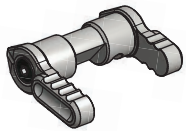

Ambidextrous 60°/90°
safety selector switch

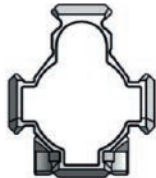

Handguard QUADRAIL225
(compatible with Mil-Spec 1913 Picatinny)



Strong barrel length 10,5" / 266,7mm
caliber 5,56 / .223 Rem.

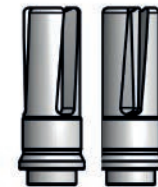

3-prong flash hider
Antreg VULCAN F1[®]



ARS M4s[®] 0Q[®] LW

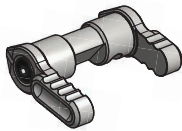

Ambidextrous 60°/90°
safety selector switch

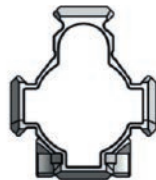

Handguard QUADRAIL225
(compatible with Mil-Spec 1913 Picatinny)



Lightweight barrel length 10,5" / 266,7mm
caliber 5,56 / .223 Rem.

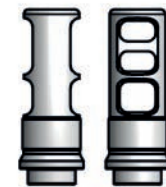

Muzzle brake
Antreg VULCAN M1[®]



Photography: ANTREG

ARS M4s[®] 0M[®]

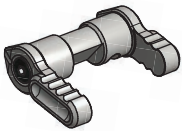

Ambidextrous 60°/90°
safety selector switch

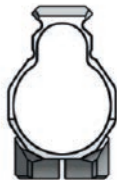

Handguard M-LOK225 + Picatinny Top
(compatible with Mil-Spec 1913 Picatinny)



Strong barrel length 10,5" / 266,7mm
caliber 5,56 / .223 Rem.

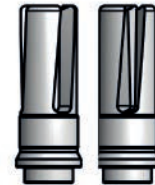

3-prong flash hider
Antreg VULCAN F1[®]



Photography: Michal Šteflovíč and Petr Bařina

ARS M4s[®] 0M[®] LW

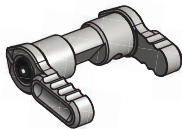

Ambidextrous 60°/90°
safety selector switch

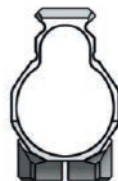

Handguard M-LOK225 + Picatinny Top
(compatible with Mil-Spec 1913 Picatinny)



Lightweight barrel length 10,5" / 266,7mm
caliber 5,56 / .223 Rem.

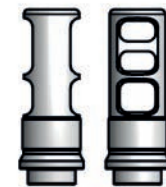

Muzzle brake
Antreg VULCAN M1[®]



ARS M4s[®] 2Q[®]

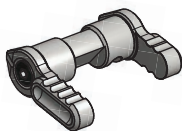

Ambidextrous 60°/90°
safety selector switch

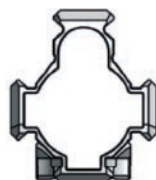

Handguard QUADRAIL 300
(compatible with Mil-Spec 1913 Picatinny)



Strong barrel length 12,5" / 317,5mm
caliber 5,56 / .223 Rem.



3-prong flash hider
Antreg VULCAN F1[®]



Photography: Michal Šteflovíč and Petr Bařina

ARS M4s[®] 2Q[®] LW

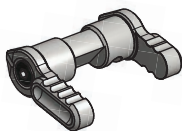

Ambidextrous 60°/90°
safety selector switch

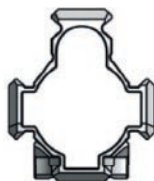

Handguard QUADRAIL300
(compatible with Mil-Spec 1913 Picatinny)



Lightweight barrel length 12,5" / 317,5mm
caliber 5,56 / .223 Rem.



Muzzle brake
Antreg VULCAN M1[®]



ARS M4s[®] 2M[®]

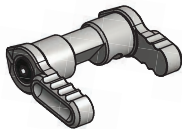

Ambidextrous 60°/90°
safety selector switch

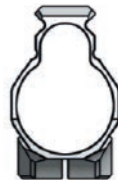

Handguard M-LOK300 + Picatinny Top
(compatible with Mil-Spec 1913 Picatinny)



Strong barrel length 12,5" / 317,5mm
caliber 5,56 / .223 Rem.

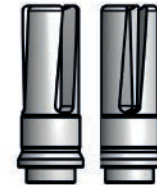

3-prong flash hider
Antreg VULCAN F1[®]



ARS M4s[®] 2M[®] LW

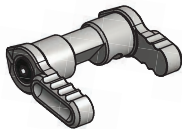

Ambidextrous 60°/90°
safety selector switch

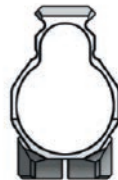

Handguard M-LOK300 + Picatinny Top
(compatible with Mil-Spec 1913 Picatinny)



Lightweight barrel length 12,5" / 317,5mm
caliber 5,56 / .223 Rem.



Muzzle brake
Antreg VULCAN M1[®]



ARS M4s[®] 2M[®] PRO

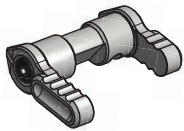

Ambidextrous 60°/90°
safety selector switch

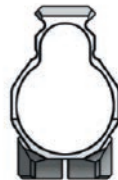

Handguard M-LOK300 PRO + Picatinny Top
(compatible with Mil-Spec 1913 Picatinny)



Strong barrel length 12,5" / 317,5mm
caliber 5,56 / .223 Rem.

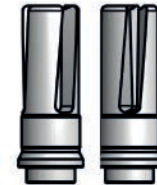

3-prong flash hider
Antreg VULCAN F1[®]



ARS M4s[®] 2M[®] LW PRO

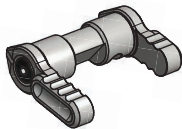

Ambidextrous 60°/90°
safety selector switch

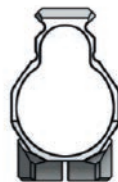

Handguard M-LOK300 PRO + Picatinny Top
(compatible with Mil-Spec 1913 Picatinny)



Lightweight barrel length 12,5" / 317,5mm
caliber 5,56 / .223 Rem.



Muzzle brake
Antreg VULCAN M1[®]



ARS M4s[®] 4Q[®]

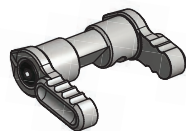

Ambidextrous 60°/90°
safety selector switch

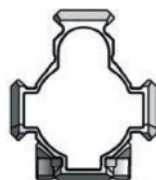

Handguard QUADRIL300
(compatible with Mil-Spec 1913 Picatinny)



Strong barrel length 14,5" / 368,3mm
caliber 5,56 / .223 Rem.



3-prong flash hider
Antreg VULCAN F1[®]



Photography: Michal Šteflovíč and Petr Bařina

ARS M4s[®] 4Q[®] LW

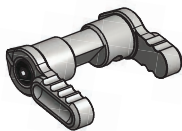

Ambidextrous 60°/90°
safety selector switch

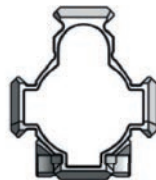

Handguard QUADRAIL300
(compatible with Mil-Spec 1913 Picatinny)



Lightweight barrel length 14,5" / 368,3mm
caliber 5,56 / .223 Rem.



Muzzle brake
Antreg VULCAN M1[®]



A
ANTREG
ARS M&S
CZECH REPUBLIC
225 Rem.
DY190004

MAGPUL

ARS M4s[®] 4M[®]

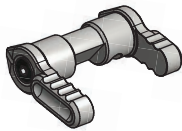

Ambidextrous 60°/90°
safety selector switch

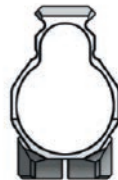

Handguard M-LOK300 + Picatinny Top
(compatible with Mil-Spec 1913
Picatinny)



Strong barrel length 14,5" / 368,3mm
caliber 5,56 / .223 Rem.

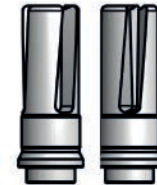

3-prong flash hider
Antreg VULCAN F1[®]



ARS M4s[®] 4M[®] LW

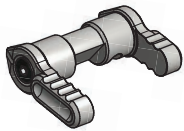

Ambidextrous 60°/90°
safety selector switch

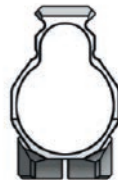

Handguard M-LOK300 PRO + Picatinny Top
(compatible with Mil-Spec 1913 Picatinny)



Lightweight barrel length 14,5" / 368,3mm
caliber 5,56 / .223 Rem.



Muzzle brake
Antreg VULCAN M1[®]



ARS M4s[®] 4M[®] PRO

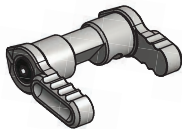

Ambidextrous 60°/90°
safety selector switch

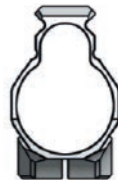

Handguard M-LOK300 PRO + Picatinny Top
(compatible with Mil-Spec 1913 Picatinny)



Strong barrel length 14,5" / 368,3mm
caliber 5,56 / .223 Rem.

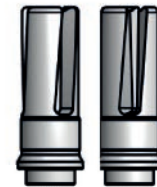

3-prong flash hider
Antreg VULCAN F1[®]



ARS M4s[®] 4M[®] LW PRO

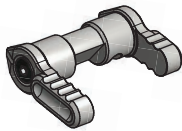

Ambidextrous 60°/90°
safety selector switch

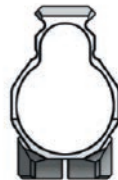

Handguard M-LOK300 PRO + Picatinny Top
(compatible with Mil-Spec 1913 Picatinny)



Lightweight barrel length 14,5" / 368,3mm
caliber 5,56 / .223 Rem.



Muzzle brake
Antreg VULCAN M1[®]



ARS M4s[®] 6Q[®]

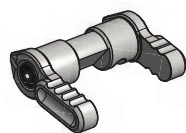

Ambidextrous 60°/90°
safety selector switch

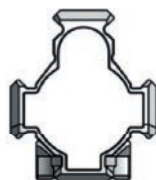

Handguard QUADRAIL 300
(compatible with Mil-Spec 1913 Picatinny)



Strong barrel length 16,5" / 419,1mm
caliber 5,56 / .223 Rem.



3-prong flash hider
Antreg VULCAN F1[®]



ARS M4s[®] 6Q[®] LW

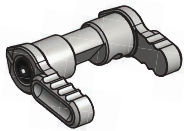

Ambidextrous 60°/90°
safety selector switch

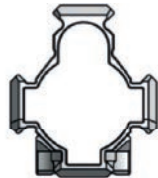

Handguard QUADRAIL300
(compatible with Mil-Spec 1913
Picatinny)



Lightweight barrel length 16,5"/ 419,1mm
caliber 5,56 / .223 Rem.

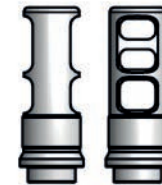

Muzzle brake
Antreg VULCAN M1[®]



ARS M4s[®] 6M[®]

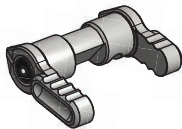

Ambidextrous 60°/90°
safety selector switch

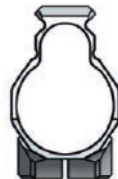

Handguard M-LOK300 PRO + Picatinny Top
(compatible with Mil-Spec 1913 Picatinny)



Strong barrel length 16,5" / 419,1mm
caliber 5,56 / .223 Rem.

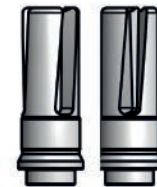

3-prong flash hider
Antreg VULCAN F1[®]



ARS M4s[®] 6M[®] LW

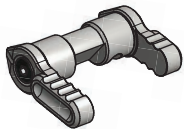

Ambidextrous 60°/90°
safety selector switch

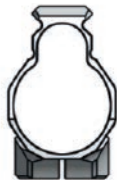

Handguard M-LOK300 + Picatinny Top
(compatible with Mil-Spec 1913 Picatinny)



Lightweight barrel length 16,5" / 419,1mm
caliber 5,56 / .223 Rem.



Muzzle brake
Antreg VULCAN M1[®]



ARS M4s[®] 6M[®] PRO

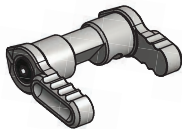

Ambidextrous 60°/90°
safety selector switch

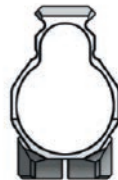

Handguard M-LOK300 PRO + Picatinny Top
(compatible with Mil-Spec 1913 Picatinny)



Strong barrel length 16,5" / 419,1mm
caliber 5,56 / .223 Rem.

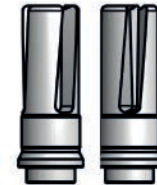

3-prong flash hider
Antreg VULCAN F1[®]



ARS M4s[®] 6M[®] LW PRO

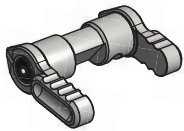

Ambidextrous 60°/90°
safety selector switch

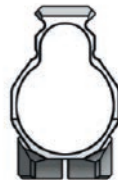

Handguard M-LOK300 PRO + Picatinny Top
(compatible with Mil-Spec 1913 Picatinny)



Lightweight barrel length 16,5" / 419,1mm
caliber 5,56 / .223 Rem.

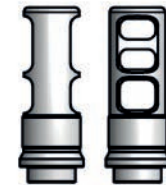

Muzzle brake
Antreg VULCAN M1[®]



Photography: Michal Šteflovíč and Petr Bařina

ARS M4s[®] 8Q[®]

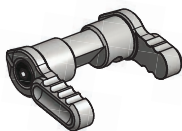

Ambidextrous 60°/90°
safety selector switch

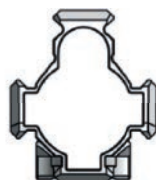

Handguard QUADRAIL300
(compatible with s Mil-Spec 1913 Picatinny)



Strong barrel length 18" / 457,2mm
caliber 5,56 / .223 Rem.



3-prong flash hider
Antreg VULCAN F1[®]



ARS M4s[®] 8Q[®] LW

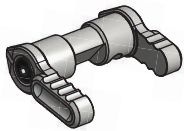

Ambidextrous 60°/90°
safety selector switch

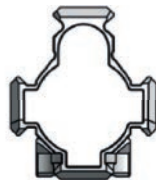

Handguard QUADRAIL300
(compatible with Mil-Spec 1913 Picatinny)



Lightweight barrel length 18" / 457,2mm
caliber 5,56 / .223 Rem.



Muzzle brake
Antreg VULCAN M1[®]



ARS M4s[®] 8M[®]

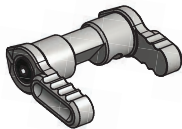

Ambidextrous 60°/90°
safety selector switch

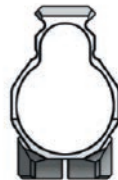

Handguard M-LOK300 + Picatinny Top
(compatible with Mil-Spec 1913 Picatinny)



Strong barrel length 18" / 457,2mm
caliber 5,56 / .223 Rem.

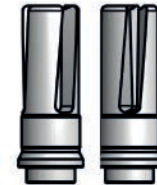

3-prong flash hider
Antreg VULCAN F1[®]



ARS M4s[®] 8M[®] LW

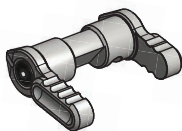

Ambidextrous 60°/90°
safety selector switch

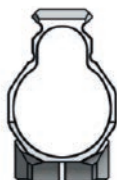

Handguard M-LOK300 + Picatinny Top
(compatible with Mil-Spec 1913 Picatinny)



Lightweight barrel length 18" / 457,2mm
caliber 5,56 / .223 Rem.



Muzzle brake
Antreg VULCAN M1[®]



ARS M4s[®] 8M[®] PRO

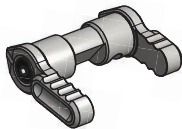

Ambidextrous 60°/90°
safety selector switch

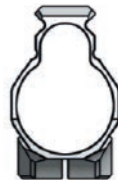

M-LOK300 PRO + Picatinny Top
(compatible with Mil-Spec 1913 Pica tinny)



Strong barrel length 18" / 457,2mm
caliber 5,56 / .223 Rem.

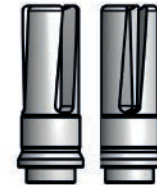

3-prong flash hider
Antreg VULCAN F1[®]



ARS M4s[®] 8M[®] LW PRO

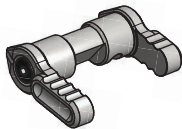

Ambidextrous 60°/90°
safety selector switch

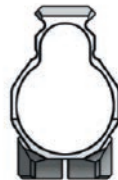

Handguard M-LOK300 PRO + Picatinny Top
(compatible with Mil-Spec 1913 Picatinny)



Lightweight barrel length 18" / 457,2mm
caliber 5,56 / .223 Rem.



Muzzle brake
Antreg VULCAN M1[®]

Overview of rifles

Model	Caliber	Barrel	Barrel profile	Twist	Weight	Length (collapsed stock)	QuadRail 225	M-LOK 225	QuadRail 300	M-LOK 300	M-LOK 300 PRO
ARS M4s 0Q	.223Rem / 5,56mm	10,5" / 266,7mm	Strong	1:7	7,31lbs / 3318g	28,35" / 720mm	●				
ARS M4s 0Q LW	.223Rem / 5,56mm	10,5" / 266,7mm	Light Weight	1:7	7,00lbs / 3175g	28,35" / 720mm	●				
ARS M4s 0M	.223Rem / 5,56mm	10,5" / 266,7mm	Strong	1:7	7,20lbs / 3268g	28,35" / 720mm		●			
ARS M4s 0M LW	.223Rem / 5,56mm	10,5" / 266,7mm	Light Weight	1:7	6,88lbs / 3125g	28,35" / 720mm		●			
ARS M4s 2Q	.223Rem / 5,56mm	12,5" / 317,5mm	Strong	1:7	7,77lbs / 3526g	30,31" / 770mm			●		
ARS M4s 2Q LW	.223Rem / 5,56mm	12,5" / 317,5mm	Light Weight	1:7	7,40lbs / 3360g	30,31" / 770mm			●		
ARS M4s 2M	.223Rem / 5,56mm	12,5" / 317,5mm	Strong	1:7	7,53lbs / 3416g	30,31" / 770mm				●	
ARS M4s 2M LW	.223Rem / 5,56mm	12,5" / 317,5mm	Light Weight	1:7	7,16lbs / 3250g	30,31" / 770mm				●	
ARS M4s 2M PRO	.223Rem / 5,56mm	12,5" / 317,5mm	Strong	1:7	7,44lbs / 3376g	30,31" / 770mm					●
ARS M4s 2M LW PRO	.223Rem / 5,56mm	12,5" / 317,5mm	Light Weight	1:7	7,07lbs / 3210g	30,31" / 770mm					●
ARS M4s 4Q	.223Rem / 5,56mm	14,5" / 368,3mm	Strong	1:7	7,97lbs / 3617g	32,32" / 821mm			●		
ARS M4s 4Q LW	.223Rem / 5,56mm	14,5" / 368,3mm	Light Weight	1:7	7,52lbs / 3415g	32,32" / 821mm			●		
ARS M4s 4M	.223Rem / 5,56mm	14,5" / 368,3mm	Strong	1:7	7,75lbs / 3517g	32,32" / 821mm				●	
ARS M4s 4M LW	.223Rem / 5,56mm	14,5" / 368,3mm	Light Weight	1:7	7,30lbs / 3315g	32,32" / 821mm				●	
ARS M4s 4M PRO	.223Rem / 5,56mm	14,5" / 368,3mm	Strong	1:7	7,67lbs / 3482g	32,32" / 821mm					●
ARS M4s 4M LW PRO	.223Rem / 5,56mm	14,5" / 368,3mm	Light Weight	1:7	7,32lbs / 3280g	32,32" / 821mm					●
ARS M4s 6Q	.223Rem / 5,56mm	16,5" / 368,3mm	Strong	1:8	8,33lbs / 3779g	34,33" / 872mm			●		
ARS M4s 6Q LW	.223Rem / 5,56mm	16,5" / 368,3mm	Light Weight	1:8	7,82lbs / 3550g	34,33" / 872mm			●		
ARS M4s 6M	.223Rem / 5,56mm	16,5" / 368,3mm	Strong	1:8	8,11lbs / 3679g	34,33" / 872mm				●	
ARS M4s 6M LW	.223Rem / 5,56mm	16,5" / 368,3mm	Light Weight	1:8	7,60lbs / 3450g	34,33" / 872mm				●	
ARS M4s 6M PRO	.223Rem / 5,56mm	16,5" / 368,3mm	Strong	1:8	8,02lbs / 3639g	34,33" / 872mm					●
ARS M4s 6M LW PRO	.223Rem / 5,56mm	16,5" / 368,3mm	Light Weight	1:8	7,51lbs / 3410g	34,33" / 872mm					●
ARS M4s 8Q	.223Rem / 5,56mm	18" / 457,2 mm	Strong	1:8	8,51lbs / 3862g	35,86" / 911mm			●		
ARS M4s 8Q LW	.223Rem / 5,56mm	18" / 457,2 mm	Light Weight	1:8	7,93lbs / 3600g	35,86" / 911mm			●		
ARS M4s 8M	.223Rem / 5,56mm	18" / 457,2 mm	Strong	1:8	8,29lbs / 3762g	35,86" / 911mm				●	
ARS M4s 8M LW	.223Rem / 5,56mm	18" / 457,2 mm	Light Weight	1:8	7,71lbs / 3500g	35,86" / 911mm				●	
ARS M4s 8M PRO	.223Rem / 5,56mm	18" / 457,2 mm	Strong	1:8	8,20lbs / 3722g	35,86" / 911mm					●
ARS M4s 8M LW PRO	.223Rem / 5,56mm	18" / 457,2 mm	Light Weight	1:8	7,62lbs / 3460g	35,86" / 911mm					●





www.ANTREG.cz

